

# M

## Coordinate Measuring Machines



### Coordinate Measuring Machines

#### INDEX

##### Coordinate Measuring Machines

CRYSTA-Apex S Series	M-2
Crysta-Apex C Series	M-3
LEGEX Series	M-4
STRATO-Apex Series	M-5
FALCIO Apex G Series (larger size models)	M-6
Crysta-Apex C Series (larger size models)	M-6
CARBstrato / CARBapex Series	M-7
MACH-V565 / 9106, MACH-3A 653	M-8
Crysta-Plus M400 / 500 / 700 Series	M-9
SpinArm-Apex	M-10
CP Series	M-11
CMM Probes	M-11
MCOSMOS	M-12

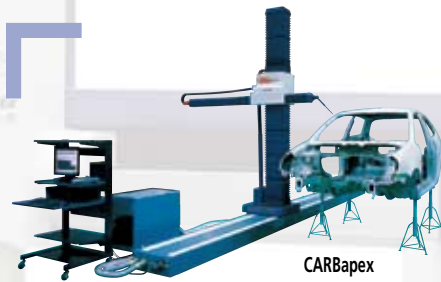

# N

## Vision Measuring Systems Others



### Vision Measuring Systems

#### INDEX

##### Vision Measuring Systems

QV ELF	N-1
QV Apex / Hyper QV	N-2
QV ACCEL	N-3
QV STREAM PLUS	N-4
QV HYBRID TYPE1, TYPE3	N-5
ULTRA QV	N-6
Accessory for Quick Vision	N-7
Quick Scope	N-8
Quick Image	N-9



Mitutoyo

# CRYSTA-Apex S Series

## SERIES 191 — Standard CNC CMM

Designed and constructed using all Mitutoyo's experience in CNC CMM technology, CRYSTA-Apex S and Crysta-Apex C feature lightweight materials and an innovative machine structure, providing high motion stability, high accuracy, and affordability. The temperature correction function (16°C to 26°C) can yield accurate measurements even on the shop floor. In addition to point-to-point measurement, the MPP-310Q and Metris Laser probes provide a contact/non-contact scanning function.



CRYSTA-Apex S776



CRYSTA-Apex S544



CRYSTA-Apex S9106



Temperature compensation system (photo: temperature sensors)



Joystick controller

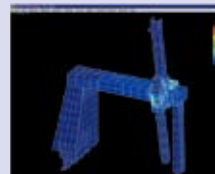
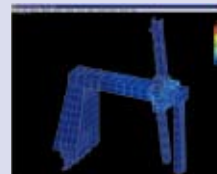

The machine structure has been optimized using FEM (Finite-Element Method) and modal analysis.

### Technical Data

Length standard:	High accuracy linear encoder
Guide system:	Air bearing
Max. drive speed:	519mm/sec
Max. acceleration:	2309mm/sec <sup>2</sup> (1732mm/sec <sup>2</sup> Type 2800)
Air pressure:	0.4MPa
Air consumption:	50L/min (500 series) 60L/min (700, 900 series) 100L/min (1200 series) 150L/min (1600, 2000 series)

### Guaranteed accuracy temperature environment\*

Temperature range		18°C - 22°C	16°C - 26°C
Temperature change	Per hour	1.0K	1.0K
	Per 24 hours	2.0K	5.0K
Temperature gradient	Vertical	1.0K/m	1.0K/m
	Horizontal	1.0K/m	1.0K/m

\*When using temperature compensation system.

### Main Unit Startup System

This machine incorporates a startup system (relocation detection system), which disables operation when an unexpected vibration is applied or the machine is relocated. Be sure to contact your nearest Mitutoyo prior to relocating this machine after initial installation. Refer to page VIII for details.

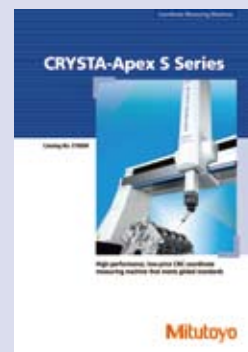

Refer to the CRYSTA-Apex S Series leaflet (E16004) for more details.

## SPECIFICATIONS

Model No.		CRYSTA-Apex S544	CRYSTA-Apex S574	CRYSTA-Apex S776	CRYSTA-Apex S7106	CRYSTA-Apex S9106 [CRYSTA-Apex S9108]	CRYSTA-Apex S9166 [CRYSTA-Apex S9168]	CRYSTA-Apex S9206 [CRYSTA-Apex S9208]
Range	X-axis	505mm	505mm	705mm	705mm	905mm	905mm	905mm
	Y-axis	405mm	705mm	705mm	1005mm	1005mm	1605mm	2005mm
	Z-axis	405mm	405mm	605mm	605mm	605mm [805mm]	605mm [805mm]	605mm [805mm]
Resolution		0.1µm	0.1µm	0.1µm	0.1µm	0.1µm	0.1µm	0.1µm
Accuracy*	MPEE	(1.7+3L/1000)µm, (1.7+4L/1000)µm**		(1.7+3L/1000)µm, (1.7+4L/1000)µm**		(1.7+3L/1000)µm, (1.7+4L/1000)µm**		
	MPEP	1.7µm		1.7µm		1.7µm		
	MPE <sub>THP</sub>	2.3µm		2.3µm		2.3µm		
Work table	Material	Granite	Granite	Granite	Granite	Granite	Granite	Granite
	Size	638 x 860mm	638 x 1160mm	880 x 1420mm	880 x 1720mm	1080 x 1720mm	1080 x 2320mm	1080 x 2720mm
	Tapped insert	M8 x 1.25mm	M8 x 1.25mm	M8 x 1.25mm	M8 x 1.25mm	M8 x 1.25mm	M8 x 1.25mm	M8 x 1.25mm
Workpiece	Max. height	545mm	545mm	800mm	800mm	800mm [1000mm]	800mm [1000mm]	800mm [1000mm]
	Max. loading	180kg	180kg	800kg	1000kg	1200kg	1500kg	1800kg
Mass (main unit)		515kg	625kg	1675kg	1951kg	2231kg [2261kg]	2868kg [2898kg]	3912kg [3942kg]

\* The machine is equipped with the temperature compensation system.

According to ISO 10360-2 methods when using the SP25M probe system with a ø4 x 50mm stylus. L: Measuring length (mm)

\*\*Guaranteed accuracy temperature range: 16°C - 26°C.

# Crysta-Apex C Series

## SERIES 191 — Standard CNC CMM



Crysta-Apex C122010

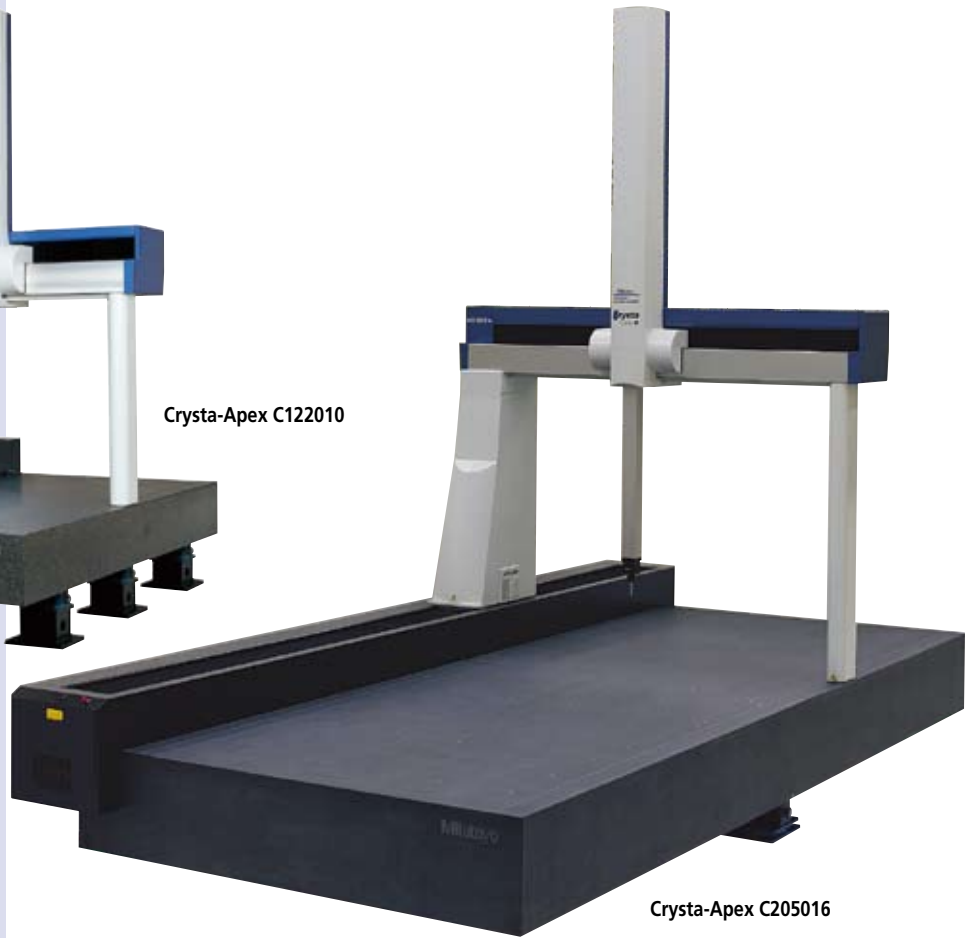

Crysta-Apex C205016

### Main Unit Startup System

This machine incorporates a startup system (relocation detection system), which disables operation when an unexpected vibration is applied or the machine is relocated. Be sure to contact your nearest Mitutoyo prior to relocating this machine after initial installation. Refer to page VIII for details.

## SPECIFICATIONS

Model No.		Crysta-Apex C121210	Crysta-Apex C122010	Crysta-Apex C123010	Crysta-Apex C163012 [Crysta-Apex C163016]	Crysta-Apex C164012 [Crysta-Apex C164016]	Crysta-Apex C165012 [Crysta-Apex C165016]
Range	X-axis	1205mm	1205mm	1205mm	1605mm	1605mm	1605mm
	Y-axis	1205mm	2005mm	3005mm	3005mm	4005mm	5005mm
	Z-axis	1005mm	1005mm	1005mm	1205mm [1605mm]	1205mm [1605mm]	1205mm [1605mm]
Resolution		0.1µm	0.1µm	0.1µm	0.1µm	0.1µm	0.1µm
Accuracy*	MPE <sub>E</sub>	(2.3+3L/1000)µm, (2.3+4L/1000)µm**			(3.3+4.5L/1000)µm, (3.3+5.5L/1000)µm**, [(4.5+5.5L/1000)µm, (4.5+6.5L/1000)µm]**		
	MPE <sub>P</sub>	2.0µm			5.0µm [6.0µm]		
	MPE <sub>THP</sub>	2.8µm			5.0µm [5.0µm]		
Work table	Material	Granite	Granite	Granite	Granite	Granite	Granite
	Size	1400 x 2165mm	1400 x 2965mm	1400 x 3965mm	1800 x 4205mm	1800 x 5205mm	1800 x 6205mm
	Tapped insert	M8 x 1.25mm	M8 x 1.25mm	M8 x 1.25mm	M8 x 1.25mm	M8 x 1.25mm	M8 x 1.25mm
Workpiece	Max. height	1200mm	1200mm	1200mm	1400mm [1800mm]	1400mm [1800mm]	1400mm [1800mm]
	Max. load	2000kg	2500kg	3000kg	3500kg	4500kg	5000kg
Mass (main unit)		4050kg	6150kg	9110kg	10600kg [10650kg]	14800kg [14850kg]	19500kg [19550kg]

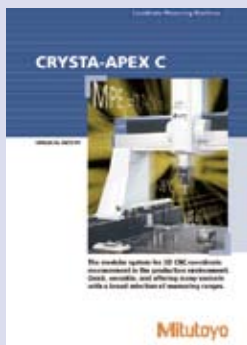

Refer to the Crysta-Apex C Series leaflet (E4275) for more details.

Model No.		Crysta-Apex C203016 [Crysta-Apex C203020]	Crysta-Apex C204016 [Crysta-Apex C204020]	Crysta-Apex C205016 [Crysta-Apex C205020]
Range	X-axis	2005mm	2005mm	2005mm
	Y-axis	3005mm	4005mm	5005mm
	Z-axis	1605mm [2005mm]	1605mm [2005mm]	1605mm [2005mm]
Resolution		0.1µm	0.1µm	0.1µm
Accuracy*	MPE <sub>E</sub>	(4.5+8L/1000)µm, (4.5+9L/1000)µm** [(6+9L/1000)µm, (6+10L/1000)µm]**		
	MPE <sub>P</sub>	6.0µm [7.5µm]		
	MPE <sub>THP</sub>	6.0µm [7.5µm]		
Work table	Material	Granite	Granite	Granite
	Size	2200 x 4205mm	2200 x 5205mm	2200 x 6205mm
	Tapped insert	M8 x 1.25mm	M8 x 1.25mm	M8 x 1.25mm
Workpiece	Max. height	1800mm [2200mm]	1800mm [2200mm]	1800mm [2200mm]
	Max. loading	4000kg	5000kg	6000kg
Mass (main unit)		14100kg [14150kg]	19400kg [19450kg]	28000kg [28050kg]

\* The machine is equipped with the temperature compensation system.

According to ISO 10360-2 methods when using the SP25M probe system with a ø4 x 50mm stylus. L: Measuring length (mm)

\*\*Guaranteed accuracy temperature range: 16°C - 26°C.

# LEGEX Series

## SERIES 356 — Ultra-high Accuracy CNC CMM

Achieving premium performance, the fixed bridge structure and precision air bearings running on rigid guideways ensure superior stability of motion and ultra-high measuring accuracy. Machines in this series are suitable for complex, small- to medium-sized workpieces such as gears, bearings, lenses, dies and scroll rotors which must be inspected to exceptionally high dimensional accuracy. The MPP-310Q probe adds a scanning function to the standard point-to-point measurement.

### FEATURES

- The most accurate CNC CMM family is launched, made possible by rigorous analysis of all possible error-producing factors and elimination or minimization of their effects.
- A newly developed, ultra-high accuracy crystallized-glass scale with the ultra-low expansion coefficient of  $0.01 \times 10^{-6}/K$  is used on each axis.
- The fixed bridge structure and precision air bearings running on highly rigid guideways ensure superior motion stability and ultra-high geometrical accuracy.
- Many types of optional probe systems are available, including touch-trigger probes, laser scanning probes, and a vision measuring probe.



Mitutoyo original standard type glass scale (above) and ultra-high accuracy glass scale with virtually zero thermal expansion (below)



CMM calibration using a virtually zero thermal expansion glass gage

### Technical Data

Length standard:	Ultra high accuracy linear encoder (glass scale with virtually zero thermal expansion coefficient)
Guide system:	Air bearing
Max. drive speed:	200mm/sec
Max. acceleration:	1000mm/sec <sup>2</sup>
Air pressure:	0.4MPa (0.5MPa: LEGEX 9106)
Air consumption:	120L/min

### Guaranteed accuracy temperature environment\*

Temperature range		20±2°C
Temperature change	Per hour	0.5K
	Per 24 hours	1.0K
Temperature gradient	Vertical	1.0K/m
	Horizontal	1.0K/m

\*When using temperature compensation system.

#### Main Unit Startup System

This machine incorporates a startup system (relocation detection system), which disables operation when an unexpected vibration is applied or the machine is relocated. Be sure to contact your nearest Mitutoyo prior to relocating this machine after initial installation. Refer to page VIII for details.



Refer to the LEGEX 300/500/700/900/1200 leaflet (E4172) for more details.



LEGEX 574



LEGEX 774

## SPECIFICATIONS

Model No.		LEGEX 574	LEGEX 774	LEGEX 776	LEGEX 9106	LEGEX 12128
Range	X-axis	510mm	710mm	710mm	910mm	1210mm
	Y-axis	710mm	710mm	710mm	1010mm	1210mm
	Z-axis	455mm	455mm	605mm	605mm	810mm
Resolution		0.01μm	0.01μm	0.01μm	0.01μm	0.01μm
Accuracy*	MPE <sub>E</sub>	(0.35+L/1000)μm	(0.35+L/1000)μm	(0.35+L/1000)μm	(0.35+L/1000)μm	(0.6+1.5L/1000)μm
	MPE <sub>P</sub>	0.45μm	0.45μm	0.45μm	0.45μm	0.6μm
	MPE <sub>THP</sub>	1.4μm	1.4μm	1.4μm	1.4μm	1.8μm
Work table	Material	Cast iron	Cast iron	Cast iron	Cast iron	Cast iron
	Size	550 x 750mm	750 x 750mm	750 x 750mm	950 x 1050mm	1250 x 1250mm
	Tapped insert	M8 x 1.25mm	M8 x 1.25mm	M8 x 1.25mm	M8 x 1.25mm	M8 x 1.25mm
Workpiece	Max. height	706mm	696mm	862mm	856mm	1056mm
	Max. loading	200kg	500kg	500kg	800kg	1000kg
Mass (main unit)		3900kg	5000kg	5100kg	6500kg	10500kg

\* The machine is equipped with the temperature compensation system. According to ISO 10360-2 methods when using the MPP-310Q probe system. L: Measuring length (mm)

# STRATO-Apex Series

## SERIES 355 — High Accuracy CNC CMM

### FEATURES

- High speed and accuracy in measurement is ensured by a redesign of the machine body that has improved rigidity of the structure, and by a remodeled guide mechanism.
- High-performance scanning measurement has been achieved through the improved structural rigidity and incorporation of a newly developed compensation technology.
- Ultra-high precision scales are used on each axis to provide a higher resolution and accuracy that complements the improved overall performance.

A long-awaited, state-of-the-art CNC coordinate measuring machine that achieves high accuracy combined with high-speed operation. The high drive speed and acceleration guarantee top scanning performance in a machine that also offers high-accuracy measuring in the 1 μm class.



STRATO-Apex 9106

### Technical Data

Length standard:	High accuracy linear encoder
Guide system:	Air bearing
Max. drive speed:	519mm/sec
Max. acceleration:	2598mm/sec <sup>2</sup>
Air pressure:	0.4MPa
Air consumption:	60L/min

### Guaranteed accuracy temperature environment\*

Temperature range	19°C - 21°C	
Temperature change	Per hour	1.0K
	Per 24 hours	2.0K
Temperature gradient	Vertical	1.0K/m
	Horizontal	1.0K/m

\*When using temperature compensation system.

#### Main Unit Startup System

This machine incorporates a startup system (relocation detection system), which disables operation when an unexpected vibration is applied or the machine is relocated. Be sure to contact your nearest Mitutoyo prior to relocating this machine after initial installation. Refer to page VIII for details.

### SPECIFICATIONS

Model No.		STRATO-Apex 776	STRATO-Apex 7106	STRATO-Apex 9106	STRATO-Apex 9166
Range	X-axis	705mm	705mm	905mm	905mm
	Y-axis	705mm	1005mm	1005mm	1605mm
	Z-axis	605mm	605mm	605mm	605mm
Resolution		0.00002mm	0.00002mm	0.00002mm	0.00002mm
Accuracy*	MPE <sub>E</sub>	(0.9+2.5L/1000)μm	(0.9+2.5L/1000)μm	(0.9+2.5L/1000)μm	(0.9+2.5L/1000)μm
	MPE <sub>P</sub>	0.9μm	0.9μm	0.9μm	0.9μm
	MPE <sub>THP</sub>	1.8μm	1.8μm	1.8μm	1.8μm
Work table	Material	Granite	Granite	Granite	Granite
	Size	880 x 1420mm	880 x 1720mm	1080 x 1720mm	1080 x 2320mm
	Tapped insert	M8 x 1.25mm	M8 x 1.25mm	M8 x 1.25mm	M8 x 1.25mm
Workpiece	Max. height	770mm	770mm	770mm	770mm
	Max. loading	500kg	800kg	800kg	1200kg
Mass (main unit)		1895kg	2180kg	2410kg	3085kg

\* The machine is equipped with the temperature compensation system.  
According to ISO 10360-2 methods when using the SP25M probe system with a ø4 x 50mm stylus.  
L: Measuring length (mm)

# FALCIO Apex Series

## SERIES 355 — High Accuracy CNC CMM



FALCIO Apex 163012

### Technical Data

Length standard:	High accuracy linear encoder
Guide system:	Air bearing
Max. drive speed:	500mm/sec
Max. acceleration:	1299mm/sec <sup>2</sup>
Air pressure:	0.4MPa
Air consumption:	150L/min

### Guaranteed accuracy temperature environment\*

Temperature range	18°C - 22°C	
Temperature change	Per hour	1.0K
	Per 24 hours	2.0K
Temperature gradient	Vertical	1.0K/m
	Horizontal	1.0K/m

\*When using temperature compensation system.

#### Main Unit Startup System

This machine incorporates a startup system (relocation detection system), which disables operation when an unexpected vibration is applied or the machine is relocated. Be sure to contact your nearest Mitutoyo prior to relocating this machine after initial installation. Refer to page VIII for details.

### SPECIFICATIONS

Model No.		FALCIO Apex 162012	FALCIO Apex 163012	FALCIO Apex 164012
Range	X-axis	1605mm	1605mm	1605mm
	Y-axis	2005mm	3005mm	4005mm
	Z-axis	1205mm [1505mm]		
Resolution		0.1μm	0.1μm	0.1μm
Accuracy*	MPE <sub>E</sub>	(2.8+4L/1000)μm [(3.3+4.5L/1000)μm: Z-axis = 1505mm]		
	MPE <sub>P</sub>	2.8μm [3.3μm: Z-axis = 1505mm]		
	MPE <sub>THP</sub>	2.8μm (90s) [3.5μm (90s): Z-axis = 1505mm]		
Work table	Material	Granite	Granite	Granite
	Size	1850 x 3280mm	1850 x 4280mm	1850 x 5280mm
	Tapped insert	M8 x 1.25mm	M8 x 1.25mm	M8 x 1.25mm
Workpiece	Max. height	1350mm [1650mm]		
	Max. loading	3500kg	4000kg	4500kg
Mass (main unit)		9500kg [9600kg]	14000kg [14050kg]	25000kg [25050kg]

\* The machine is equipped with the temperature compensation system.  
According to ISO 10360-2 methods when using the SP25M probe system with a ø4 x 50mm stylus.  
L: Measuring length (mm)

# FALCIO Apex G Series

## SERIES 355 — High Accuracy Large CNC CMM

### FEATURES

This giant CNC CMM provides a huge measuring range of 2000mm x 3000mm x 1500mm to 3000mm x 5000mm x 2000mm with large-size CMM accuracy.



FALCIO Apex 305015G



#### Main Unit Startup System

This machine incorporates a startup system (relocation detection system), which disables operation when an unexpected vibration is applied or the machine is relocated. Be sure to contact your nearest Mitutoyo prior to relocating this machine after initial installation. Refer to page VIII for details.

### SPECIFICATIONS

Model No.	FALCIO Apex 203015G	FALCIO Apex 204015G	FALCIO Apex 205015G	FALCIO Apex 305015G	
Range	X-axis	2005mm	2005mm	3005mm	
	Y-axis	3005mm	4005mm	5005mm	
	Z-axis	1505mm [2005mm]	1505mm [2005mm]	1505mm [2005mm]	
Resolution	0.1μm	0.1μm	0.1μm	0.1μm	
Accuracy*	MPE <sub>E</sub>	(3.5+4L/1000)μm [(4+4.5L/1000)μm: Z-axis=2005mm]			
	MPE <sub>P</sub>	3.5μm [4μm: Z-axis=2005mm]			
	MPE <sub>THP</sub>	3.8μm (90s) [4.2μm (90s): Z-axis=2005mm]			
Mass (main unit)	12000kg	14000kg	15000kg	16000kg	

\* The machine is equipped with the temperature compensation system.  
According to ISO 10360-2 methods when using the SP25M probe system with a ø4 x 50mm stylus. L: Measuring length (mm)

### Technical Data

Length standard: High accuracy linear encoder  
Guide system: Air bearing  
Max. drive speed: 520mm/sec

### Guaranteed accuracy temperature environment\*

Temperature range	18°C - 22°C	
Temperature change	Per hour	1.0K
	Per 24 hours	2.0K
Temperature gradient	Vertical	1.0K/m
	Horizontal	1.0K/m

\*When using temperature compensation system.

# Crysta-Apex C Series

## SERIES 191 — Standard Large CNC CMM



### SPECIFICATIONS

Model No.	Crysta-Apex C203016G	Crysta-Apex C306016G	
Range	X-axis	2005mm	3005mm
	Y-axis	3005mm	6005mm
	Z-axis	1605mm [2005mm]	1605mm [2005mm]
Resolution	0.1μm	0.1μm	
Accuracy*	MPE <sub>E</sub>	(6+6L/1000)μm [(7+7L/1000)μm: Z-axis=2005mm]	
	MPE <sub>P</sub>	6μm [7μm: Z-axis=2005mm]	
	MPE <sub>THP</sub>	6.5μm (90s) [7.5μm (90s): Z-axis=2005mm]	
Mass (main unit)	12000kg	16000kg	

\* The machine is equipped with the temperature compensation system.  
According to ISO 10360-2 methods when using the SP25M probe system with a ø4 x 50mm stylus. L: Measuring length (mm)

### Technical Data

Length standard: High accuracy linear encoder  
Guide system: Air bearing  
Max. drive speed: 500mm/sec

### Guaranteed accuracy temperature environment\*

Temperature range	18°C - 22°C	
Temperature change	Per hour	1.0K
	Per 24 hours	2.0K
Temperature gradient	Vertical	1.0K/m
	Horizontal	1.0K/m

\*When using temperature compensation system.

#### Main Unit Startup System

This machine incorporates a startup system (relocation detection system), which disables operation when an unexpected vibration is applied or the machine is relocated. Be sure to contact your nearest Mitutoyo prior to relocating this machine after initial installation. Refer to page VIII for details.

# CARBstrato / CARBapex Series

## SERIES 360 — Car Body Measuring System

### FEATURES: CARBstrato

A large, high precision, horizontal-type CNC CMM for measuring car bodies. Single/dual-head types are available; the dual-head type measures by controlling two heads simultaneously, one from each side.

### FEATURES: CARBapex

A large, affordable, horizontal-type CNC CMM for measuring car bodies. Single/dual-head types are available; the dual-head type measures by controlling two heads simultaneously, one from each side.

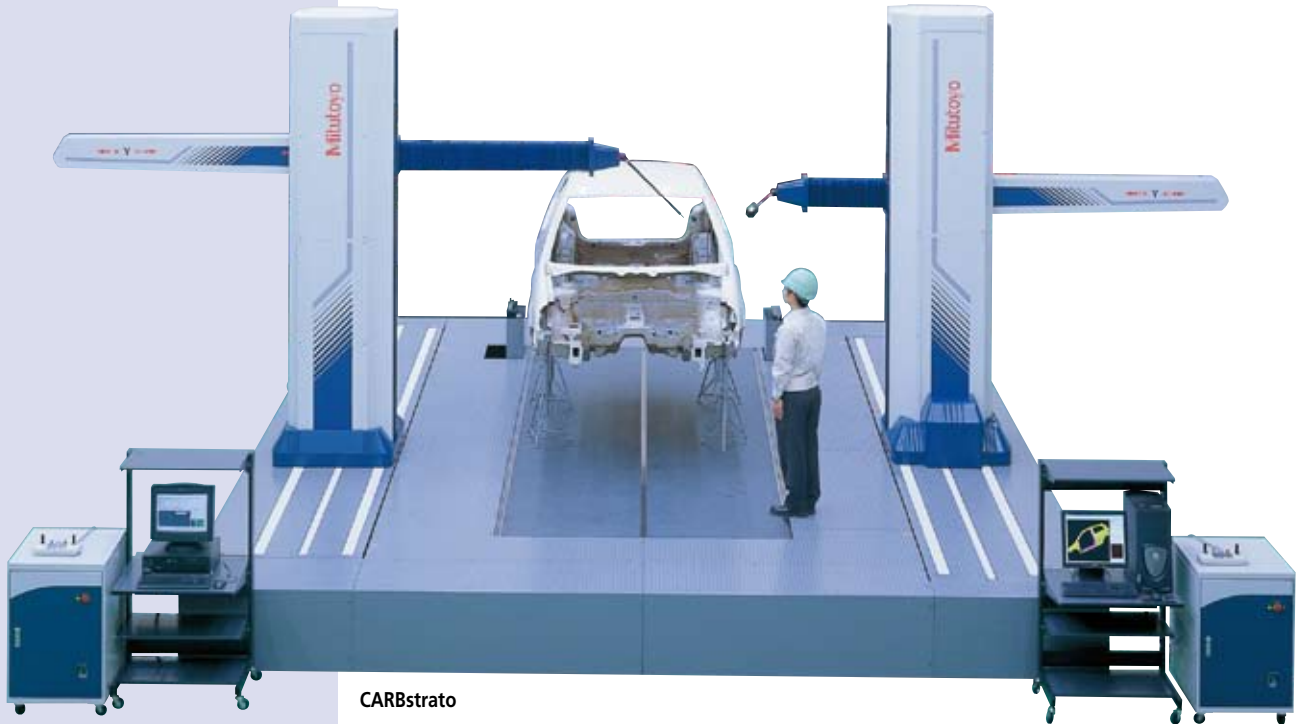

CARBstrato



### Technical Data

Length standard: High accuracy linear encoder  
 Guide system: X-axis: linear guide, YZ-axis: Air bearing  
 Max. drive speed: 866mm/sec (CARBstrato)  
 519mm/sec (CARBapex)  
 Max. acceleration: 2037mm/s<sup>2</sup> (CARBstrato) 980mm/s<sup>2</sup> (CARBapex)

### Guaranteed accuracy temperature environment\*

Temperature range	16°C - 26°C	
Temperature change	Per hour	1.0K
	Per 24 hours	5.0K
Temperature gradient	Vertical	1.0K/m
	Horizontal	1.0K/m

\*When using temperature compensation system.

#### Main Unit Startup System

This machine incorporates a startup system (relocation detection system), which disables operation when an unexpected vibration is applied or the machine is relocated. Be sure to contact your nearest Mitutoyo prior to relocating this machine after initial installation. Refer to the page VIII for details.

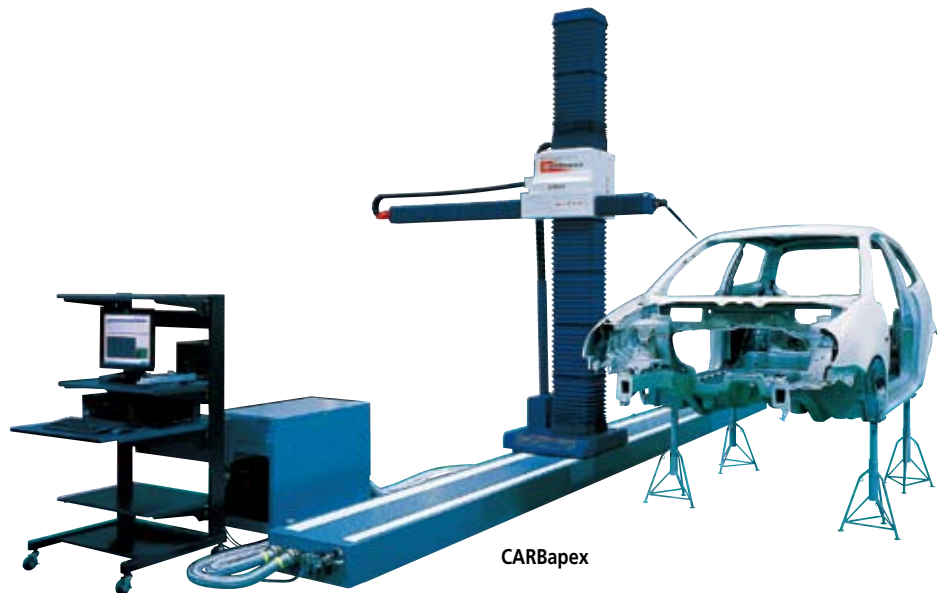

CARBapex

### SPECIFICATIONS

Model No.		CARBstrato	CARBapex
Range	X-axis	4000 - 8000mm	4000 - 8000mm
	Y-axis	1400 - 1600mm	1400 - 1600mm
	Z-axis	2000 - 2600mm	2000 - 2600mm
Resolution		1μm	1μm
Accuracy*	MPE <sub>E</sub>	(18+20L/1000)μm	(25+28L/1000)μm

\* The machine is equipped with the temperature compensation system. According to ISO 10360-2 methods when using the SP25M probe system with a ø4 x 50mm stylus. L: Measuring length (mm)

# MACH-V565 / 9106

## SERIES 360 — In-line Type CNC CMM

### FEATURES

The MACH-V maximizes machining performance by performing in-line, high speed coordinate measuring in conjunction with your CNC machine tools. These high-throughput machines can be incorporated right into the manufacturing line and can provide pre/post machining feedback to your machine tool for machining adjustments.



MACH-V9106

### SPECIFICATIONS

Model No.	MACH-V565		MACH-V9106	
Range	X-axis	505mm	905mm	
	Y-axis	605mm	1005mm	
	Z-axis	505mm	605mm	
Resolution		0.1µm		0.1µm
Accuracy*	MPE <sub>E</sub>	(2.5+3.5L/1000)µm / (2.9+4.3L/1000)µm / (3.6+5.8L/1000)µm**		
	MPE <sub>P</sub>	2.5µm (2.2µm: using SP25M)		

\* The machine is equipped with the temperature compensation system.

According to ISO 10360-2 methods when using the TP7M probe system with a ø4 x 20mm stylus. L: Measuring length (mm)

\*\* Guaranteed accuracy temperature range: 19°C - 21°C / 15°C - 25°C / 5°C - 35°C



### Technical Data

Length standard: High accuracy linear encoder  
 Guide system: Linear guide: MACH-V  
 Max. drive speed: 866mm/sec: MACH-V  
 Max. acceleration: 8480mm/s<sup>2</sup>: MACH-V

### Guaranteed accuracy temperature environment

Temperature range	5°C - 35°C	
Temperature change	Per hour	2.0K
	Per 24 hours	10.0K
Temperature gradient	Vertical	1.0K/m
	Horizontal	1.0K/m

#### Main Unit Startup System

This machine incorporates a startup system (relocation detection system), which disables operation when an unexpected vibration is applied or the machine is relocated. Be sure to contact your nearest Mitutoyo prior to relocating this machine after initial installation. Refer to page VIII for details.

# MACH-3A 653

## SERIES 360 — In-line Type CNC CMM



### SPECIFICATIONS

Model No.	MACH-3A 653	
Range	X-axis	605mm
	Y-axis	505mm
	Z-axis	285mm
Resolution		0.1µm
Accuracy*	MPE <sub>E</sub>	(2.5+3.5L/1000)µm, (2.8+4.2L/1000)µm, (3.2+5.0L/1000)µm, (3.5+5.7L/1000)µm, (3.9+6.5L/1000)µm**
	MPE <sub>P</sub>	2.5µm

\* The machine is equipped with the temperature compensation system.

According to ISO 10360-2 methods when using the TP7M probe system with a ø4 x 20mm stylus. L: Measuring length (mm)

\*\* Guaranteed accuracy temperature range: 19°C - 21°C / 15°C - 25°C / 10°C - 30°C / 5°C - 35°C / 35°C - 40°C

### Technical Data

Length standard: High accuracy linear encoder  
 Guide system: Linear guide  
 Max. drive speed: 1212mm/sec  
 Max. acceleration: 11882mm/s<sup>2</sup>

### Guaranteed accuracy temperature environment

Temperature range	5°C - 40°C	
Temperature change	Per hour	2.0K
	Per 24 hours	10.0K
Temperature gradient	Vertical	1.0K/m
	Horizontal	1.0K/m

#### Main Unit Startup System

This machine incorporates a startup system (relocation detection system), which disables operation when an unexpected vibration is applied or the machine is relocated. Be sure to contact your nearest Mitutoyo prior to relocating this machine after initial installation. Refer to page VIII for details.

# Crysta-Plus M443 / 500 / 700 Series

## SERIES 196 — Manual-Floating Type CMM



One-touch air clamp and fine feed for rapid and easy positioning

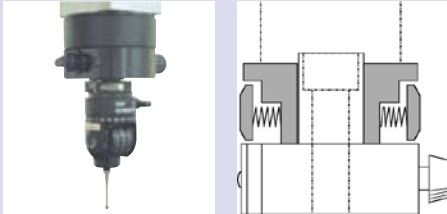

Ergonomically designed guide grip on Z-axis for reliable measurement  
(only for Crysta-Plus M776 and M7106)



Probe illumination (optional) to illuminate the probe and styli directly and brighten the working field

### Technical Data

Length standard: High accuracy linear encoder  
Guide system: Air bearing  
Axis clamp: One-touch air clamp  
(Screw clamp: M776, M7106)  
Fine feed range: Entire range  
Air pressure: 0.4MPa (0.35MPa: M443, M544, M574)  
Air consumption: 50L/min

### Guaranteed accuracy temperature environment

Temperature range		19°C - 21°C	15°C - 30°C*
Temperature change	Per hour	—	<b>2.0K</b>
	Per 24 hours	—	<b>5.0K</b>
Temperature gradient	Vertical	0.5K/m	<b>1.0K/m</b>
	Horizontal	0.5K/m	<b>1.0K/m</b>

\*The values shown in Bold in the table above apply to the case when using the temperature compensation system. (Option)



Refer to the CRYSTA-PLUS M 443/500/700 leaflet (E4332-196) for more details.

Manual floating type CMMs developed in the quest for high-accuracy, low-cost and easy operation. The Crysta-Plus M is applicable to a wide range of applications from simple dimension to complex form measurement.

### FEATURES

- Smooth operation due to high-precision air bearings and lightweight moving members.
- Continuous fine feed over the entire measuring range.

Crysta-Plus M443



Crysta-Plus M574



Crysta-Plus M7106

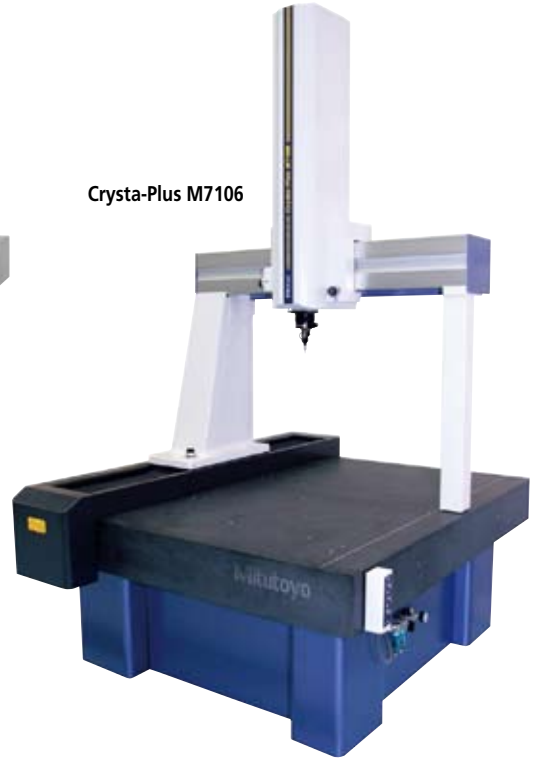

### SPECIFICATIONS

Model No.		Crysta-Plus M443	Crysta-Plus M544	Crysta-Plus M574	Crysta-Plus M776	Crysta-Plus M7106
Range	X-axis	400mm	500mm	500mm	700mm	700mm
	Y-axis	400mm	400mm	700mm	700mm	1000mm
	Z-axis	300mm	400mm	400mm	600mm	600mm
Resolution		0.5μm	0.5μm	0.5μm	0.5μm	0.5μm
	Accuracy*	E (3.0+4.0L/1000)μm	(3.5+4.0L/1000)μm		(4.5+4.5L/1000)μm	
Work table	Material	Granite	Granite	Granite	Granite	Granite
	Size	624 x 805mm	764 x 875mm	764 x 1175mm	900 x 1440mm	900 x 1740mm
	Tapped insert	M8 x 1.25mm	M8 x 1.25mm	M8 x 1.25mm	M8 x 1.25mm	M8 x 1.25mm
Workpiece	Max. height	480mm	595mm	595mm	800mm	800mm
	Max. loading	180kg	180kg	180kg	500kg	800kg
Mass (main unit)		360kg	450kg	575kg	1451kg	1697kg

\*The temperature compensation system is optionally available.  
According to ISO 10360-2 methods when using the TP20 probe system. L: Measuring length (mm)

# SpinArm-Apex

## SERIES 198 — Multi-axis Portable Coordinate Measuring System

### FEATURES

- Able to approach the workpiece from any direction.
- Excellent portability means it can perform measurement close to the workpiece.
- With counterbalancing, high operativity is achieved.
- Non-contact line laser probe and the contact probe can be mounted together.



SpinArm-Apex 366S



SpinArm-Apex 367H



SpinArm-Apex is a fully articulated coordinate measuring system featuring a wide range of measurement. The highly portable design of SpinArm-Apex enables the system to be positioned at any point near the workpiece.

- Enables measurement of workpieces of complex shape in any direction.
- Portability enables the measurement system to be positioned close to the workpiece.
- Brake mechanism enhances the usability greatly.
- Counterbalance for easier operation.
- Supports both non-contact line laser probes and contact probes concurrently.

\* Not for use in or export to the United States.



### SPECIFICATIONS

Model No.	SpinArm-Apex 186S	SpinArm-Apex 246S	SpinArm-Apex 306S	SpinArm-Apex 366S
Measuring envelope*	1800mm	2400mm	3000mm	3600mm
Repeatability**	±0.040mm	±0.050mm	±0.080mm	±0.100mm
Accuracy**	±0.055mm	±0.065mm	±0.100mm	±0.135mm
Mass (main unit)	14.5kg	14.7kg	15.2kg	15.6kg

Model No.	SpinArm-Apex 247S	SpinArm-Apex 307S	SpinArm-Apex 367S
Measuring envelope*	2400mm	3000mm	3600mm
Repeatability**	±0.055mm	±0.090mm	±0.110mm
Accuracy**	±0.080mm	±0.135mm	±0.165mm
Mass (main unit)	15.1kg	15.6kg	16.0kg

\* Measurement range is expressed as a diameter value at the maximum reach using software with the Sφ10 mm standard probe mounted.

\*\* According to Mitutoyo's acceptance procedure.

• Guaranteed accuracy temperature: 20°±4° (Temperature gradient: 1.5° per hour)

# CP Series

## SERIES 355 — Horizontal-arm Type Manual CMM

- **Measuring Large Workpieces**  
Large workpieces that exceed the measuring range of the CP1057 can be measured, indirectly, by moving the CP1057's main unit along the surface plate and linking the measurement results obtained before and after movement.
- **A Choice of Probes**  
Various probes are available for the CP1057, such as a point probe that can be used for scribed-line pointing measurements, in addition to the standard touch-trigger probe.
- **Temperature Compensation System (Option)**  
An optional temperature compensation system can be installed in the CP1057 to ensure measuring accuracy is maintained over a wide temperature range (15°C to 30°C).

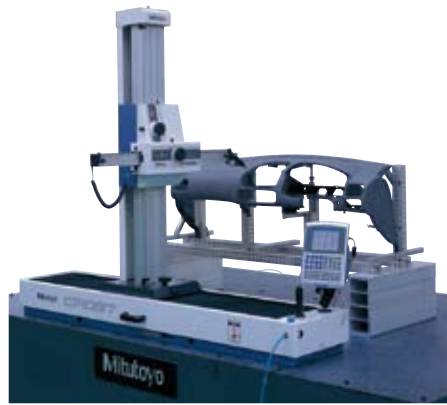

### SPECIFICATIONS

Model No.	<b>CP1057</b>	
Range (X-axis, Y-axis, Z-axis)	1000 x 500 x 750mm	
Resolution	0.5μm	
Accuracy*	E	(15+10L/1000)μm
	R	12μm
Probe positioning	Manual via control wheels	
Air supply	Pressure	0.4MPa
	Consumption	40L/min
Mass (main unit)	225kg	

\*The temperature compensation system is optionally available.  
According to ISO 10360-2 methods when using the TP20 probe system.  
L: Measuring length (mm)

### Guaranteed accuracy temperature environment

Temperature range	19°C - 21°C	<b>15°C - 30°C*</b>
Temperature change	—	<b>2.0K/h, 5.0K/24h</b>
Temperature gradient	0.5K/m (vertical, horizontal)	<b>1.0K/m (vertical, horizontal)</b>

\*The values shown in Bold in the table above apply to the case when using the temperature compensation system. (Option)

## CMM Probes

### Dynamic measuring probe system



**MPP-310Q**  
Ultra-high accuracy and low measuring force type



**SP80**  
High accuracy type and available with 500mm long extension



**MPP-10**  
for effective thread-depth measurement



**SP25M**  
Compact and high accuracy type

### Touch-trigger measuring probe system



**TP7M**  
High accuracy type



**TP200**  
Compact and high accuracy (stylus change) type



**TP20** Compact type



**Micro Touch probe**  
UMAP-CMM



**TP8**  
Manual Indexable Probe

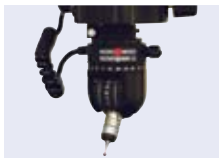

**MH20i / MH20** High accuracy type



### Probe heads



**PH10M / PH10MQ**  
Motor drive index type



**MIH**  
Manual index type



**PH1**  
Simple manual type

### Optical (non-contact) measuring probe system



**SurfaceMeasure606**



**QVP (Quick Vision Probe)**  
for video measurement



**CF20**  
Centering microscope system

# MCOSMOS

## Software for Manual / CNC Coordinate Measuring Machines

### Three levels of module configuration

MCOSMOS has three choices of module configuration. From the simple set of MCOSMOS-1 to the advanced set of MCOSMOS-3, you can choose the best configuration for your measurement applications.

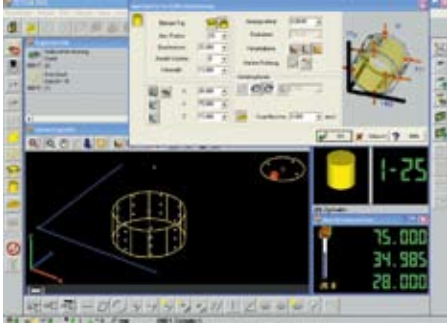

#### GEOPAK (Geometry module)

"Geopak" is our universal geometric measurement program, which allows you to control the measurement of your workpiece from drawing to completion, or simply to run existing measurement programs on a repeat basis.

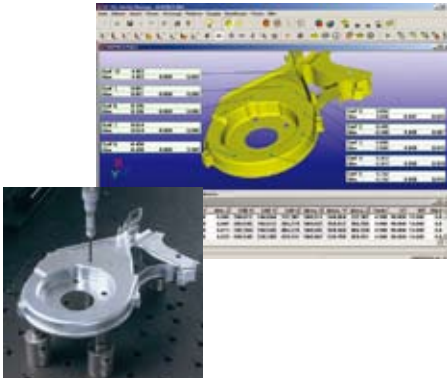

#### CAT1000S (free form surface evaluation module)

In addition to online/offline part program creation, CAD model based generation of surface measurement points, and comparison of actual/nominal data, with graphical output.



#### GEARPAK (gear measurement and analysis module)

Advances in CMM controller techniques make the measurement of gears feasible, and the "GEARPAK" module takes advantage of this to bring sophisticated measurement capabilities within easy reach.

Module included	GEOPAK	CAT1000P	CAT1000S	SCANPAK
MCOSMOS-1	✓	—	—	—
MCOSMOS-2	✓	✓	—	—
MCOSMOS-3	✓	✓	✓	✓



#### CAT1000P (offline part program module)

For online/offline part program creation, using the measurement of geometric elements directly from the CAD model, with automatic collision avoidance.

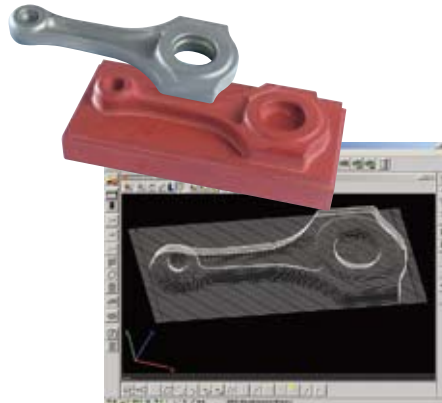

#### SCANPAK (2D profile evaluation module)

For the scanning and evaluation of workpiece contours (2D), and data transfer to CAD system.



#### MAFIS (Mitutoyo Airfoil Inspection System)

Evaluation and analysis of airfoil shape such as Turbine Blades requires special calculations according to the particular design specifications. The "MAFIS" system uses cross sectional data of the shape obtained by "SCANPAK" to perform these calculations, and output the result via the standard geometry program.



Refer to the MCOSMOS leaflet (E4180) for more details.